

# ROBAM



## User Manual

### **KQWS-2400-R305**

### Electric Oven

# Contents



Safety Precautions .....	1
Product Introduction .....	3
Installation Instructions .....	5
Operation Instructions .....	6
Common Faults and Fault Dropping .....	13
Maintenance and Care .....	13
Electrical Schematic Diagram .....	15

## Safety Precautions









In order to avoid any harm or property damage to the users and other persons, following distinctions and signs are specially given.

All these are the important notices concerned with safety, so please abide by these notices strictly. And, please use this product correctly on the premise that all the contents herein are understood fully.







Distinctions on contents made in accordance with extent of harm and damage















 Danger	Personal risk, serious injury or a fire may be very likely caused if this sign is neglected and the product is operated improperly.
 Warning	Personal risk, serious injury or a fire may be caused if this sign is neglected and the product is operated improperly.
 Notice	Personal injury or damage to objects may be caused if this sign is neglected and the product is operated improperly.







Signs of the behaviors that shall be paid attention to or that shall be prohibited

 Prohibited	 No open flames	 No touch	 No remove	 Abide by strictly	 To be grounded	 Electric shock danger	 Hot surface
--	--	--	---	---	---	---	---

 **Warning** Please use this product strictly in accordance with contents of this Operation Manual. Our company is not reliable for any property loss or personal injury caused by improper using of this product.

 <b>Danger</b>	
 <b>Abide by strictly</b> Before disconnecting plug from the socket, you should grip the end of the plug. Be sure not to disconnect the plug with power wire in your hand, otherwise such dangers as electric shock, short out and fire may be caused .	 <b>Prohibited</b> Be sure not to use a power socket which is loose or contacted poorly, otherwise such dangers as electric shock, short out and fire may be caused.
 <b>Abide by strictly</b> In order to avoid the electric shock that may occur, please ensure that the appliance has been disconnected from power before replacement of a bulb.	 <b>Abide by strictly</b> The complete appliance shall be kept far away from heat sources and inflammables (e.g. gas and alcohol).
 <b>Hot surface</b> During use the appliance becomes hot. Care should be taken to avoid touching heating elements inside the oven. when taking out foods after using, make sure to wear the high-temperature resistant protective gloves properly in order to avoid burns.	

 Warning	
 Abide by strictly If the supply cord is damaged, it must be replaced by the manufacturer, its service agent or similarly qualified persons in order to avoid a hazard.	 To be grounded Use a separate 16A or higher socket, and be sure not to connect several appliances to the same power socket at the same time, and make sure that the socket is grounded safely and effectively.
 Abide by strictly If the appliance functions improperly, make sure to disconnect it from the power and stop using immediately. And, be sure not to touch the appliance and that it is repaired by a professional.	 Abide by strictly Make sure the power cord is not damaged. When using the power cord, make sure that the cord is not bent, stretched, twisted or knotted. And, Be sure not to press or attack the power cord with weight.
 Abide by strictly You should cut off the power before cleaning of the appliance and use a neutral detergent to clean it. Moreover, make sure to clean it with a soft piece of cloth, in order to prevent its surface from being scratched.	 Abide by strictly Make sure to disconnect the electric oven from power before removing the fan guard. After cleaning, reset the guard properly to the original position in accordance with the Operation Manual.
 Abide by strictly Turn off the appliance immediately after using, otherwise the residual fat may cause a fire; in case the appliance is not to be used for an extended period of time, please cut off the power.	 Abide by strictly Hot air may come out when door of the appliance is opened after using, so please be sure not to stand too close to the appliance to avoid burns caused by the hot air.
 Abide by strictly WARNING: Accessible parts may become hot during use. Young children should be kept away.	 Abide by strictly WARNING: Ensure that the appliance is switched off before replacing the lamp to avoid the possibility of electric shock.
 Prohibited Do not use harsh abrasive cleaners or sharp metal scrapers to clean the oven door glass, since they can scratch the surface, which may result in shattering of the glass.	 Prohibited Never place any flammable substance (e.g. smoke agent) in or under the appliance; when using the appliance, be sure not to spray any smoke agent around it and that the appliance is always supervised.
 Abide by strictly In order to prevent a fire, the appliance should be kept clean and the air duct should be kept smooth.	 Abide by strictly Be sure not to operate the appliance when any of your hand or foot is wet or your feet are bare.
 Prohibited This appliance is not intended for use by persons (including children) with reduced physical, sensory or mental capabilities, or lack of experience and knowledge, unless they have been given supervision or instruction concerning use of the appliance by a person responsible for their safety. Children should be supervised to ensure that they do not play with the appliance.	

 Notice	
 Abide by strictly If the appliance functions abnormally, please disconnect the power plug and power it on again.	 Abide by strictly The internal grills and ovenware, etc. should be placed properly during using.
 Prohibited Be sure not to use a steam cleaner.	 Prohibited The appliance cannot be used as an indoor heater.
 Abide by strictly Use a temperature sensor recommended for this electric oven.	

## Product Introduction

### Dear users:

We take this opportunity to express our heartfelt thanks to you for your choosing of ROBAM brand electric oven series products. We especially recommend that you shall read this Manual carefully before installing and using this product and keep it properly for later reference.

Our company is a professional corporation specializing in production of household appliances and kitchen wares such as extractor hoods, electric ovens, gas cookers and disinfector cabinets in China. The electric oven of ROBAM brand adopts advanced design concept and optimized molding and focuses on matching with cabinet in the aspect of overall design.

### Important Information

#### Packaging of electric oven

Please dispose these packaging materials in an environment-friendly way, in order to keep a good environment. Be sure not to allow children to play with the packaging materials (e.g. plastic film and carton box, etc.), otherwise it would lead to suffocation accident. So, please keep children away from the packaging materials.

### Product Characteristics

- Adopts the intelligent one-touch menu for easy operation and better baking taste;
- The built-in full-automatic precise temperature probe adopts the dual temperature control technology to improve the food baking quality;
- The high-temperature enamel inner container is durable with flip heating pipes, easy to remove & clean;
- Specially made hinge integrated with the multi-layer tempered glass door, easy and flexible to open and close;
- Multi-function baking selections to meet the diverse baking demands and make it easy for operation;
- Specially designed professional baking modes with upper and lower dual temperature controls, to meet diverse baking tastes;
- Good quality baking heaters enables quick heat-up and efficient heating to extend the service life;
- Adopts the energy efficient, environmental & high-temperature resistant cotton to secure the good heat preservation performance and thus save more energy during baking.

### Technical Parameters of the Product

Item No.	KQWS-2400-R305
Rated Voltage	220-240V~
Rated Frequency	50Hz
Rated Power	2400W
Capacity	40L
Net Weight	34.5kg
Outside Dimension W × H × D(mm)	595 × 455 × 520

## Product Structure

(The picture is for reference only, specifications are subject to the physical product)

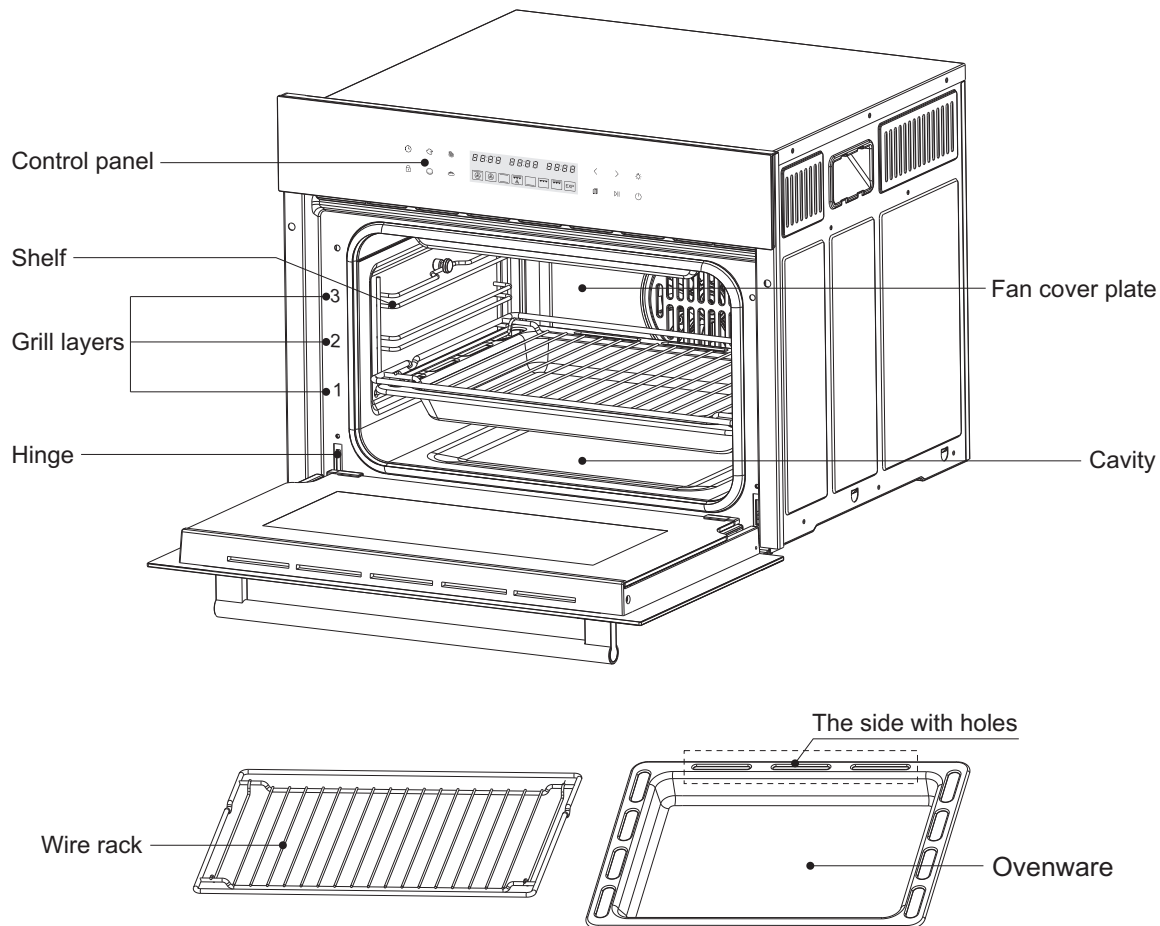

Note: when placing the ovenware, the side with holes shall be placed inward.  
The Wire rack should be placed in the shelf.

## List of Accessories

S/N	Name	Quantity
1	User Manual	1copy
2	Wire rack	2copy
3	Ovenware	1copy
4	Mounting screw	2copy

## Installation Instructions

Drill a square hole on the setting position of the cabinet according to the installation drawing as shown below, insert the electric oven into this square hole stably and keep the electric oven horizontal. The specific dimensions of the hole are as shown in following table:

S/N	Name	A	B	C
1	Dimensions of the hole for full insertion (W x H x D)	600	460	565
2	Dimensions of the hole for semi-insertion (W x H x D)	560	450	550

(The pictures are for reference only and the specifications are subject to the physical product)

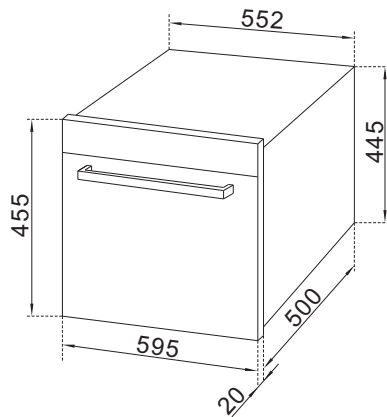

Complete dimensions diagram

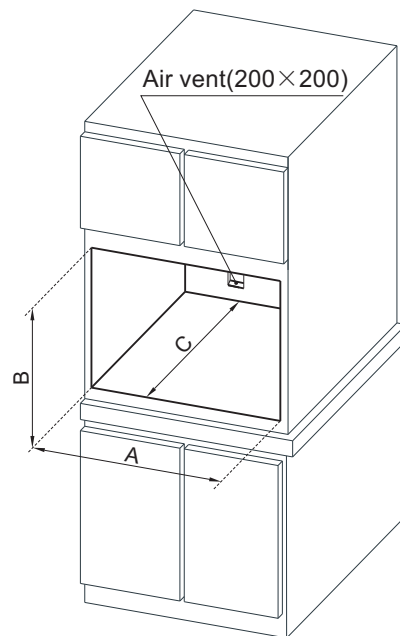

Semi-insertion hole diagram

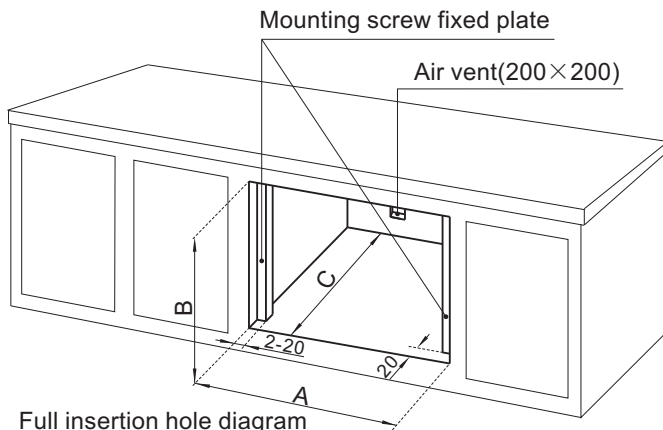

Full insertion hole diagram

### Installation Requirements:

- The oven must not be installed behind a decorative door in order to avoid overheating.
- The surface where the electric oven is to be placed on should be flat and the air around the electric oven mounted in the cabinet shall be ventilated well as much as possible. It is recommended that the clamping plates and fixed plates shall adopt incombustible thermal insulation material.
- For easy connection and disconnection of power cord, be sure to disconnect the power supply at any time after the installation of the oven. a separate 16A or higher socket shall be used, be sure not to connect several appliances to the same power socket at the same time, and that the socket is grounded safely and effectively. In case there is any other electrical appliances around, please keep a 100mm or larger mounting distance.

## Operation Instructions

### Introduction to Control Panel

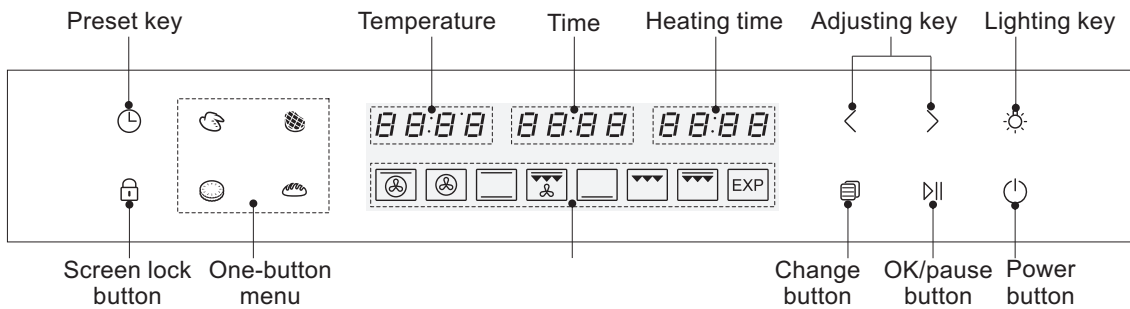

### Operation Instructions

- First use of the electric oven will generate the abnormal odor, due to protective coating on the heating components at the storage and the coating evaporated after heating up. Thus keep the room in good ventilation condition and select the fan baking function. Set the max. temperature & working time and heat up without food to evaporate the coating odor. When operation completes, open the oven door to cool down so as to secure the good taste for future baking.
- After the unit is powered off, if the temperature of the internal components is still too high, the fan will stop operation after some time, which is helpful to extend the service life of the unit.

**Tips: when the electric oven is in use, it is recommended to switch on the the extractor hood.**

### Using Methods

#### 1. Power on

When plug in, there will be a sound. All the indicators light up (see below figure) and light out after a few minutes. The power button flashes and the unit enters the standby mode. The display shows 12:00. If no operation in 3 minutes approximately, it will power off.

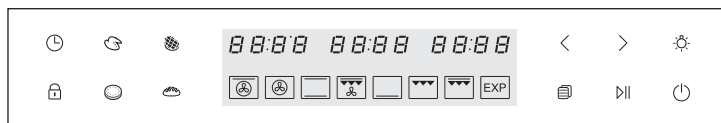

#### 2. Time Adjustment

When the display screen displays time ("12:00" in default), press and hold the "⌚" button and the "Hour" of the time will blink, then press "<" or ">" to adjust the hour. And, press the "⌚" button again so that the "Minute" of the time will blink, then press "<" or ">" to adjust the minute. The adjustment will be set automatically after several seconds, or you also can set directly by pressing the "▶||" button. The time will turn off automatically several minutes after the appliance is turned off.

**Note:** the time will restore to the default value "12:00" automatically after the power is cut off and shall be readjusted after power on.



### 3. Starting up

Press and hold the “⏻” button to power on the unit and enter to the default quick heat up mode. The icons “🔒” and “▶||” flash, indicating adjustable state (see below figure);

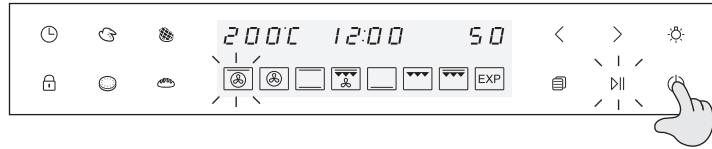

### 4. Selection of Functions

Press the “<” or “>” button to select the baking function as needed. The selected function icon flashes (e.g. select the “fan baking”, see below figure). The default temperature and time is shown on the display.



Press the “📄” button to switch to the temperature display section and the indicator flashes. Then press the “<” or “>” button to set the baking temperature (see below figure).

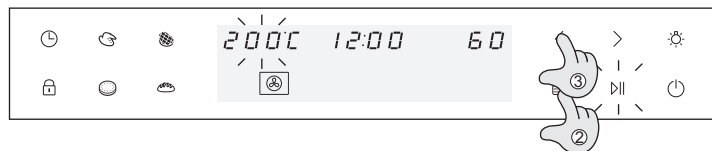

Press the “📄” button to switch to the time display section and the indicator flashes. Then press the “<” or “>” button to set the baking time (see below figure).



#### Note:

- In the event of no need to set temperature or time, press the “▶||” button directly to start after the function is selected.
- Users may refer to the baking reference table for temperature and time setting. Or set according to personal taste and cooking experience.
- “▶||” button keeps the constant flashing state before pressing on it.
- Press “📄” button to cyclically switch the temperature display section, heating time display section and function section.
- When setting the temperature and time, press and hold the “<” or “>” button to decrease or increase progressively.

### 5. Confirmation to Start up

After the function is set, press “▶||” button to start (see below figure). The electric oven automatically enters the preheat mode. When it reaches the preheat temperature, indicating sound comes up. Place the food into the oven. When the baking completes, beep comes on.

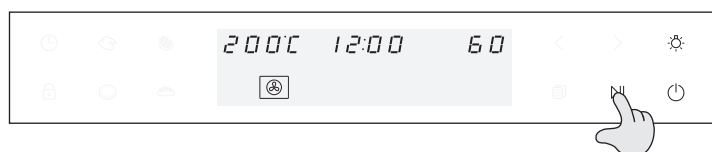

**Note:**

- During the operation, the working state may be stopped by pressing “▷||” button.
- Pay attention to the baking process from time to time. If necessary, reset the time and temperature or end the baking to avoid undesirable baking effect.
- For better food baking effect, it is recommended to preheat the unit before placing the food into the oven.

### ■ Adjustment of Settings

In the baking process, if need to change the selected baking mode, temperature or time, press the “▷||” button first to stop operation and enters to the adjustable state. Reset the function, temperature and time. Then repress the “▷||” button to start the baking.(When screen is locked, press the “🔒” button to cancel the screen lock. Then press “▷||” to stop operation and adjust the setting)

### ■ Expert Baking Mode

To meet customers' diverse baking demands and taste, the professional baking mode is specially designed.The function is capable of self-operated control the upper & lower layer of heating temperature. Operation steps are as follows:

1. Select the “EXP” professional baking mode.
2. Then press the “📖” button to enter the setting of the upper layer temperature. The display shows “1500C”. Press “<” or “>” button to adjust the temperature (see below figure)

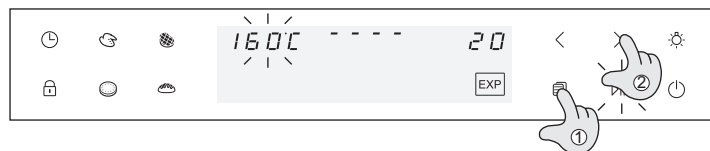

3. Press the “📖” button to enter the setting of the lower layer temperature. The display shows “1300C”. Press “<” or “>” button to adjust the temperature (see below figure)

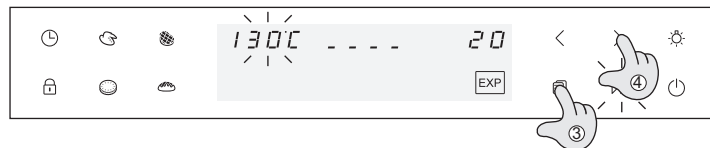

4. Press the “📖” button to enter into the setting of baking time. Press “<” or “>” button to adjust the time Press “▷||” button to start (see below figure)

When it reaches the preheat temperature, the indicating sound will be heard. Place the food into the oven. When baking finishes, the beep comes on.

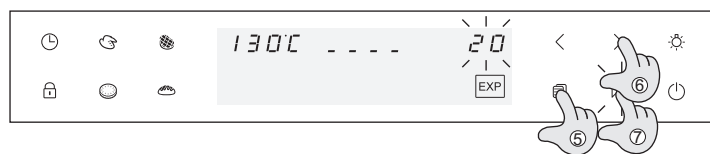

Note: the upper & lower layer temperature could be set at 30C at the maximum. The temperature at the upper and lower layer will be shown alternatively during the baking process

### ■ One-button Menu

For users quick operation, the “Chicken wing 🍗, Beef 🍖, Biscuit 🍪, Bread 🍞” one-touch menu is separately provided. Directly press the menu button needed and then press “▷||” to start. The display shows the real time temperature and counting down time (see below figure).When it reaches the preheat temperature, the indicating sound will be heard. Place the food into the oven. When baking finishes, the beep comes on.



**Note:** according to the food weight & thickness, customers may adjust the baking time by pressing “<” or “>” button when menu is selected.

- For easily baking the good tasted food, the (recipe & preparation method) is customized for the one-touch menu and for your reference. You may also adjust on your own according to your cooking experience and taste.

**Recipes and Preparation Methods**

**Roasted Chicken Wing**

Ingredient: chicken wings, New Orleans seasoning, honey & salad oil.

**Preparation Method**

1. Slantingly make two cuts on both sides of the chicken wing, to get better taste after cure.
2. Cure: add the seasoning, honey, salad oil. The cure time is recommended to be more than 2 hours.
3. Place the cured chicken wing into the roasting rack and apply with honey.
4. Select the “👉” button to start. When it reaches the preheat temperature, the indicating sound will be heard. Place the food into the second layer of the oven. The roasting will be completed automatically.

**Roast Beef**

Ingredient: whole piece of beef tenderloin, red wine, black pepper (granulate), ground black pepper, salt, rosemary (fresh), cooking oil, butter.

**Preparation Method**

1. Remove the tendon from the beef and cut into thick slices. Beat at both sides to make it soft and loose.
2. Cure: add proper amount of red wine, black pepper granulate, ground black pepper, salt, cooking oil & rosemary. Apply butter on the surface. Cure for 20-40 minutes (the longer, the better taste) after all ingredients are applied evenly.
3. Select the “🌐” button to start. When it reaches the preheat temperature, the indicating sound will be heard. Place the food into the second layer of the oven. The roasting will be completed automatically.

**Cranberry Biscuit**

Ingredient: low-gluten flour 115g, butter 75g, powdered sugar 60g, egg pulp 15ml, dried cranberry 35g.

**Preparation Method**

1. Add the powdered sugar after the butter is softened and stir to mix it evenly.
2. Add the egg pulp and stir (no need to beat into creamy or fluffy).
3. Add the mincing dried cranberry (do not mince into too small pieces).
4. Add the low-gluten flour and stir evenly into the dough. Wrap the dough with the preservative film. Manually make the dough into the rectangle shape and place it into the fridge to harden it by frozen (takes 1 hour approximately. Tips: place the dough in frozen rather than cold storage);
5. Take out the frozen dough and remove the wrap. Cut it into slices as soon as possible before it becomes soft. Then place the cut slices into the oven.
6. Select the “🍪” button to start. When it reaches the preheat temperature, the indicating sound will be heard. Place the food into the second layer of the oven. The roasting will be completed automatically.

**Tips:** Pay attention to the biscuit color during the baking process. When the baking is well done, a strong aromatic smell will come out!

## Soft Bread



Ingredient: high-gluten flour 1000g, fresh yeast 30g, salt 15g, berry sugar 160g, butter 140g, egg 4each, water 360g.

1. Cut the butter into small pieces.
2. Stir all ingredients together. Add proper amount of water as needed.
3. Manually make it into dough. Knead the dough sufficiently so that the thin film could be pulled from it.
4. Enters into the fermentation process till the dough ferment into the 2 times in size approximately. Knead the dough and divide it into the smaller dough of the same size. Make the smaller doughs into the round shape and ferment for another 20 minutes till becomes into the suitable size.
5. Place the fermented dough into the baking tray and apply evenly on the surface with a layer of egg.
6. Select the “” menu button to start. When it reaches the preheat temperature, the indicating sound will be heard. Place the food into the second layer of the oven. The roasting will be completed automatically.



**Note:** fermentation box or the oven may be used to ferment the dough (It is recommended to place a pot of hot water inside the oven when using it for fermentation to keep the certain moisture and temperature).

## ■ Preset Function

For example: current time is 9am, users would like to start cooking at 10:30. Detailed operation steps are as follows:



1. Select the baking function first. Press the “” button to set the delay function and the hour setting is actuated. Set the hour to 10 through the “<” or “>” button.
2. Then press “” button to actuate the minute setting. Press the “<” or “>” button to set the minute to 30
3. Press “” button to start the delay function. The delay menu icon flashes.
4. When the time shown on the display panel reaches “10:30”, the unit starts the baking mode automatically.



### Tips:

- Press the “” button to start the delay function. Repeat pressing the button, it will switch between the hour setting → and minute setting. Operation repeats in such way;
- If need to cancel the delay function, press and hold the “” button to cancel.
- The delay time is the time starting the baking;
- Before using the preset function, please make sure that the time displayed on the product is correct.

## ■ Screen Lock Function

This function is applicable for locking the screen in the operation to avoid the incorrect operation by children or other person:

1. In the working state, press “” button and the indicator comes up. It enters into the program locking state.
2. If need to unlock the screen, press and hold the “” button and the screen will be unlocked.

**Note:** “” and “” buttons will not be locked. In the screen lock state, if the “” button is pressed and held, the unit will be powered off.







## ■ Lighting Function

In the power on state, the lighting is automatically started. In the cooking process, press “” button to activate the lighting function. Press the button again to switch off the function. Light will switch off automatically after 1 minute with no press.

## ■ Power off

1. When the baking operation completes, the beep comes on, indicating that it stops heating and enters the standby mode.
2. In the standby mode (without any operation), the unit will automatically power off in a few minutes.
3. When the electric oven is running in the baking mode, press and hold the “” button to directly stop heating and switch to the power off state.

**Baking Reference Table**

Function	Food	Position of Grill	Apparatus Adopted	Temperature (°C)	Baking Time (min)	Remarks
 Rapid heating	Corn	2	Wire rack	215-225	25-30	
	Vegetable	2	Wire rack	200-210	8-15	
	Egg tart	2	Ovenware	200-220	15-20	
 Wind baking	Kebab	2	Wire rack	175-185	10-15	
	Potato chips	2	Ovenware	175-185	18-23	
	Sweet potato	2	Wire rack	210-220	35-45	
 Baking	Cupcake	2	Ovenware	155-165	23-28	
	Cake	1	Stainless steel cookware	155-165	23-28	2-5 eggs, suitable amount of flour (set the time and temperature according to the actual amount)
	Steamed creamy custard bun	2	Ovenware	195-205	6-11	
	Biscuit	2	Ovenware	175-185	10-18	
	Pizza	2	Ovenware	200-220	12-18	
 Fan baking	Pork chop	2	Ovenware	175-185	15-20	9~12mm/lump thick approximately
	Streaky pork	2	Ovenware	215-225	45-50	
	Bacon	2	Ovenware	195-205	7-12	2mm/lump thick approximately
	Wing middle joint	2	Wire rack	185-195	12-17	50g/each weight approximately
	Drumstick	2	Wire rack	175-185	15-20	60g/each weight approximately
	Roast duck	2	Wire rack	180-200	67-72	1800g/each weight approximately
	Roast chicken	2	Wire rack	135-155	80-85	1600g/each weight approximately
	Shrimp	2	Wire rack	175-185	8-15	
Beef	2	Wire rack	200-220	10-25	9~12mm/lump thick approximately	
 Barbecue	Pork chop	2	Ovenware	175-185	12-17	9~12mm/lump thick approximately
	Kebab	2	Wire rack	195-205	10-15	
	Sausage	2	Wire rack	195-205	15-20	
	Wing root	2	Wire rack	175-185	35-40	50g/each weight approximately
 Strong grill	Beef	2	Ovenware	195-205	12-17	9~12mm/lump thick approximately
	Sausage	2	Wire rack	185-195	15-20	
	Bacon	2	Ovenware	180-200	8-13	2mm/lump thick approximately
	Roast chicken	2	Wire rack	175-185	85-90	1200g/each weight approximately
	Wing middle joint	2	Wire rack	185-195	15-20	50g/each weight approximately
	Wing root	2	Wire rack	175-185	40-45	50g/each weight approximately
	Drumstick	2	Wire rack	185-195	15-20	50g/each weight approximately
	Kebab	2	Wire rack	215-225	15-20	
Roast fish	2	Ovenware	195-205	10-20	500g/each weight approximately	

**Note:**

- The food baking temperature and time in the above table is for reference only. Users may set the temperature, time, baking function & baking layer according to personal taste & experience.
- When roasting chicken, duck and bigger piece of meat, it is recommended to roast at lower temperature first and then switch to the higher temperature for better taste.
- Before roasting food, users may cure the food as needed by using the prepared ingredient for approximately 30-40 minutes so that the taste is better.
- Users may also select the different cooking function for the same food according to personal experience.
- In order to have even heat during the baking process, it is recommended to turn over to the other food side.

## Baking & Heating Modes

Function	Default Temperature (°C)	Default Time (min)	Upper Outer Heating Tubes	Upper Inner Heating Tubes	Bottom Heating Tubes	Rear Heating Tubes	Rear Fan	Lighting	Cooling Fan
Rapid heating	200	50	●			●	●	●	⊙
Wind baking	200	60				●	●	○	⊙
Baking	160	60	●		●			○	⊙
Fan baking	220	60	●	●			●	○	⊙
Bottom heating	160	50			●			○	⊙
Barbecue	180	50		●				○	⊙
Strong grill	180	40	●	●				○	⊙
Expert baking	Upper160 Lower130	20		●	●			○	⊙
Chicken wing	The modes and temperature will be changed and controlled automatically							○	⊙
Beef								○	⊙
Biscuit								○	⊙
Bread								○	⊙

Note: users can know the heating ways and select an appropriate baking function according to the heating modes mentioned in this table. ● Required ○ Optional ⊙ Subject to temperature control

## Common Baking Symptoms and Remedies

Symptoms	Possible Causes	Remedies
Uneven baking	<ul style="list-style-type: none"> <li>※Incorrect baking layer</li> <li>※Food is not placed in the central position of the baking tray</li> <li>※Incorrect function selected</li> </ul>	<ul style="list-style-type: none"> <li>※Select the correct baking layer position</li> <li>※Place food in the central position of the baking tray</li> <li>※Select the correct function</li> </ul>
Food baked Upper surface color Or the bottom color is too dark	<ul style="list-style-type: none"> <li>※Incorrect function selected</li> <li>※Food size is not even or food is not placed evenly</li> <li>※Baking temperature is too high</li> <li>※The baking layer position is too high or too low</li> <li>※The oven door was too frequently open during the baking process</li> </ul>	<ul style="list-style-type: none"> <li>※Select the correct function</li> <li>※Cut the food into even size and place the food evenly onto the baking tray</li> <li>※Switch to lower temperature</li> <li>※Change to the lower or higher layer</li> <li>※Do not open the oven door till half of the baking time is completed at least</li> </ul>
Cake or pastry baked has crack and deep & thick crust layer	<ul style="list-style-type: none"> <li>※Too long baking time</li> <li>※Baking temperature is too high</li> <li>※Baking layer position is too high</li> <li>※Incorrect recipe or wrong preparation process</li> <li>※Incorrect vessel selected</li> </ul>	<ul style="list-style-type: none"> <li>※Adjust the baking time</li> <li>※Switch to lower temperature</li> <li>※Place the cake/pastry in the lower layer</li> <li>※Change the recipe and correct the preparation process</li> <li>※Change to the proper vessel</li> </ul>
Food baked color is too light or not well baked	<ul style="list-style-type: none"> <li>※Baking temperature is too low</li> <li>※Baking layer position is too low</li> <li>※Too short baking time</li> </ul>	<ul style="list-style-type: none"> <li>※Adjust the baking temperature</li> <li>※Place the cake/pastry in the higher layer</li> <li>※Extend the baking time</li> </ul>

## Common Faults and Fault Dropping

Faults	Possible Causes	Fault Dropping
Electric oven will not start to work	※Power supply is not connected ※Incorrect operation of the function button	※Use after the power is connected. ※Operate correctly
Light will not come on	※Bulb is broken ※Open circuit of the bulb connection wire or loose connection	※Replace the bulb ※Contact the qualified personnel for repair.
Insufficient heat up	※Open circuit of heating pipe ※Sensor failure	※Contact the qualified personnel for repair.
Smoke comes from the electric oven for the first use	※Protective oil is evaporating	※Use cloth to wipe
Display problem E 2	※Upper fan malfunctions	※Contact the qualified personnel for repair.
Display problem E 5	※Sensor failure	※Contact the qualified personnel for repair.
Display problem E 8	※Communication failure	※Contact the qualified personnel for repair.
The solid heating pipe color fades	※It is normal for the heating components and the decoration circle color fades in the baking process	※Normal phenomenon needs no treatment

**Note:**

If the above problems could not be solved, contact ROBAM service center or the distributor. Disassembly by unqualified personnel is not allowed.

## Maintenance and Care

**Important instruction:** before cleaning the electric oven, power supply must be disconnected. Do not use steam to clean the oven.

The electric oven must be kept in clean condition to make sure no fat or grease accumulated around the heating components & fan. Baking trays & baking racks must be cleaned thoroughly to avoid the accumulated fat resulting in fire. Meat can be wrapped with the aluminum foil during roasting for easy clean. Any fat or grease may generate a layer of lacquer deposit accumulated in the oven, which is difficult to clean. Thus, the oven must be cleaned thoroughly after each use.

1. Inner chamber: use hot water for clean. Do not use corrosive or abrasive detergent to clean. Use the nylon brush or the mild detergent to clean the stubborn dirt. Do not use the steel wool for clean to avoid the unrepairable damage on the surface. The detergent inside the chamber must be cleaned without any residue. Use cloth to wipe the detergent after clean to keep the chamber in dry condition.

2. The stainless steel decorative plate: use the soft damp cloth to wipe the plate. For the grease which is difficult to remove, use the mild detergent or the special stainless steel detergent to clean. Follow the texture of the stainless steel when wiping the plate. Use clean and dry cloth to wipe the plate after cleaning.

3. Glass panel: glass on the door and control panel must be immediately cleaned when there is any dirt. Use the mild detergent to clean the stubborn dirt. Do not use the steel wool for clean to avoid any scratch on the surface. Use cloth to wipe after cleaning.

4. Disassembly and assembly of the fan lid: the fan lid is fixed by the 4 screws inside the chamber. Remove the fan lid by rotating the screws in the anticlockwise direction. Note: the fan lid must be reassembled after cleaning
5. Disassembly and assembly of the light: remove the light by rotating the glass cover in the anticlockwise direction and then rotating the bulb in the anticlockwise direction. Reassemble the light by rotating the bulb in the clockwise direction and then rotating the glass cover in the anticlockwise direction.
6. For easy clean of the top of the inner container, the upper heating pipe could be turned downwards. Rotate the fixing leg at the upper heating pipe by 90 degree (see the illustration). The front stator may be removed from the fixing leg and it can be turned downwards by 20 degree approximately (see the illustration). Re-fix the upper heating pipe by the reserved operation. Place back the stator into the heating leg and then rotate by 90 degree for clasp up.

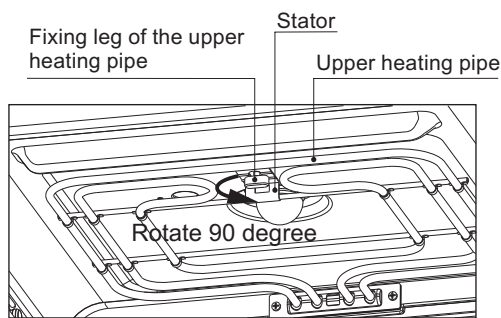

Diag. 1

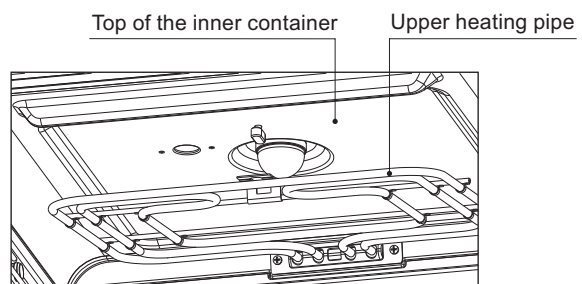

Diag. 2

7. Disassembly and assembly of the rest rack (same method for the left & right rest racks): press the location of rest rack (see the illustration) till the rack leaves the positioning screw. Take the racks out by following the arrow direction after slanting at a certain angle and disassembles the rest racks. Reassemble the rest rack by following the illustration to align and insert the lower section of the rack into the hole. Then clasp the upper section into the positioning screws.

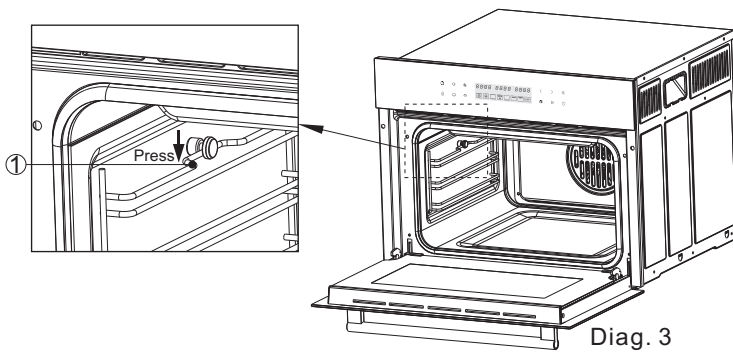

Diag. 3

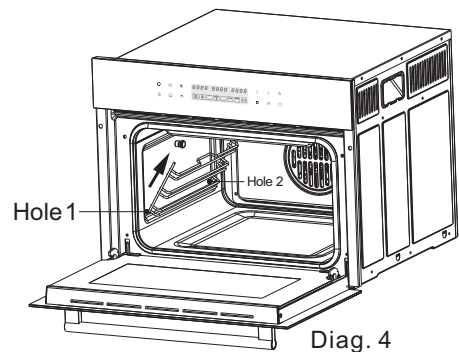

Diag. 4



## Electrical Schematic Diagram

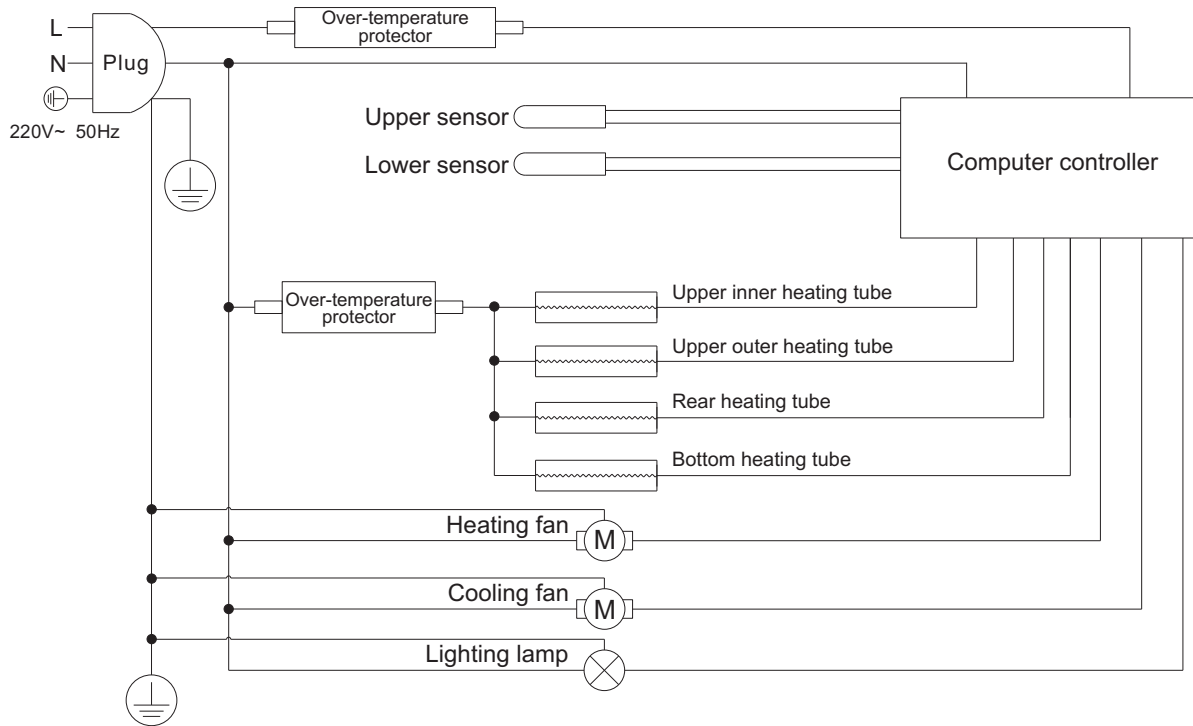

### Special Statements

Technical improvements of the product (if any) will be incorporated in the User Manual of a new version without notice. If any alteration occurs on appearance or color of the product, the actual specifications are subject to the physical product.

Edition: A/0  
Publication Date: August,01,2017

**ROBAM**